

ZOOM

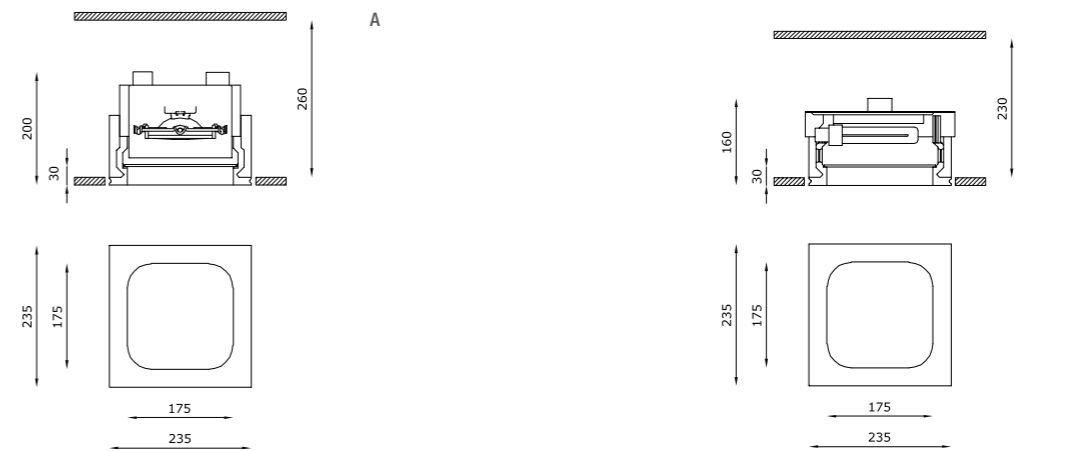

Luce che valorizza i dettagli, che illumina con delicatezza, per arredare in modo innovativo: Zoom è un incasso da interni a scomparsa totale per installazione in soffitto di cartongesso. Il corpo in AirCoral® è pensato per diventare parte integrante del controsoffitto e sparire completamente alla vista, in modo da dare assoluta importanza al fascio luminoso.

A light that enhances details, that illuminates gently, to decorate in an innovative way: Zoom is an indoor totally disappearing recessed luminaire, installable on plasterboard ceilings. Its body in AirCoral® is designed to become an integral part of the plasterboard ceiling and to completely disappear from the view in order to give absolute importance to the light beam.



TECHNICAL FEATURES

Code	6171.AC (fig. A)	6178.AC (fig. B)	6176.AC (fig. B)	6177.AC (fig. B)	6185.AC (fig. B)
Type	Tiltable downlight +/- 30° 	Downlight 90° 	Downlight 90° 	Downlight 90° 	Downlight 90°
Material	AC: AirCoral®	AC: AirCoral®	AC: AirCoral®	AC: AirCoral®	AC: AirCoral®
Absorption capacity*	7.72 m²	7.72 m²	7.72 m²	7.72 m²	7.72 m²
Weight	4.4 Kg	3.7 Kg	4 Kg	4 Kg	4.2 Kg
Mounting	Ceiling recessed	Ceiling recessed	Ceiling recessed	Ceiling recessed	Ceiling recessed
IP rating	IP40	IP40	IP40	IP40	IP40
Insulation class	III	I	I	I	I
Control gear	Dimmable electronic transformer	-	Electronic ballast	Electronic ballast	Electronic ballast
Cut out for plasterboard	245 x 245 mm	245 x 245 mm	245 x 245 mm	245 x 245 mm	245 x 245 mm
Lamp type	QR 111 	QT-DE12 (75 mm) 	TC-TEL 	TC-TEL 	TC-TEL
Lamp wattage	100W max	150W max	2 x 26/32W	2 x 42W	2 x 26W
Luminous efficacy	-	-	-	-	-
Light distribution	-	-	-	-	-
Fitting	G53	R7s	Gx24q-3	Gx24q-4	Gx24q-3
Light colour	-	-	-	-	-
Light hole	175 x 175 mm	175 x 175 mm	175 x 175 mm	175 x 175 mm	175 x 175 mm
Voltage connection	220-240V / 12V 50/60Hz	220-240V 50/60Hz	220-240V 50/60Hz	220-240V 50/60Hz	220-240V 50/60Hz
CRI	-	-	-	-	-
Emergency	-	-	-	-	1 hour
Energy efficiency class	A	A+	A	A	A
Note	Extra white satin glass. Frosted glass recessed 30 mm into the ceiling.	Extra white satin glass. Frosted glass recessed 30 mm into the ceiling.	Extra white satin glass. Frosted glass recessed 30 mm into the ceiling.	Extra white satin glass. Frosted glass recessed 30 mm into the ceiling.	Extra white satin glass. Frosted glass recessed 30 mm into the ceiling.

OPTIONAL ACCESSORIES

product code	optional code	description	info
6171.AC	00010KIT	Kit LED dimmable	Bulb 10W - 12V







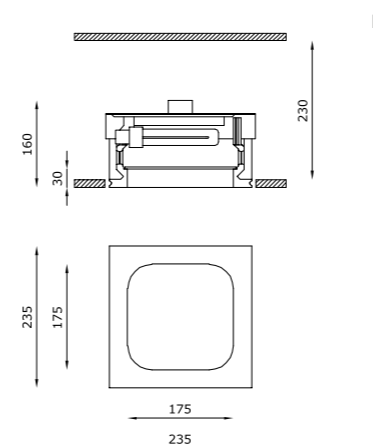



* The absorption capacity per m² calculated by the American organization TCNA (Tile Council of North America) is measured for an average room of 2,7 m in height and therefore expressed in m²



Restaurant - Cosenza



TECHNICAL FEATURES

Code	6186.AC (fig. B)	6187.AC (fig. B)	6196.P.AC (fig. B)	6181.AC (fig. B)	6183.AC (fig. B)
Type	Downlight 90° 	Downlight 90° 	Downlight 90° 	Downlight 90° 	Downlight 90° 
Material	AC: AirCoral®	AC: AirCoral®	AC: AirCoral®	AC: AirCoral®	AC: AirCoral®
Absorption capacity*	7.72 m²	7.72 m²	7.72 m²	7.72 m²	7.72 m²
Weight	4.2 Kg	5.2 Kg	4.4 Kg	3.2 Kg	3.2 Kg
Mounting	Ceiling recessed	Ceiling recessed	Ceiling recessed	Ceiling recessed	Ceiling recessed
IP rating	IP40	IP40	IP40	IP40	IP40
Insulation class	I	I	I	I	I
Control gear	Electronic ballast	Electronic ballast	Dimmable electronic ballast	Constant current electronic driver	Dimmable constant current driver
Cut out for plasterboard	245 x 245 mm	245 x 245 mm	245 x 245 mm	245 x 245 mm	245 x 245 mm
Lamp type	TC-TEL 	TC-TEL 	TC-TEL 	LED 1050 mA 	LED 350 mA 
Lamp wattage	2 x 32W	2 x 42W	2 x 42W	1 x 40W	2 x 6.5W
Luminous efficacy	-	-	-	107 lm/W - 3000K	2 x 810 lm - 3000K
Light distribution	-	-	-	Wide beam 40°	Wide beam 120°
Fitting	Gx24q-3	Gx24q-4	Gx24q-4	-	-
Light colour	-	-	-	White 3000K White 2700K 4000K (on request)	White 3000K White 2700K 4000K (on request)
Light hole	175 x 175 mm	175 x 175 mm	175 x 175 mm	175 x 175 mm	175 x 175 mm
Voltage connection	220-240V 50/60Hz	220-240V 50/60Hz	220-240V 50/60Hz	220-240V 50/60Hz	220-240V 50/60Hz
CRI	-	-	-	>80 >90 (on request)	>80
Emergency	1 hour	1 hour	-	-	-
Energy efficiency class	A	A	A	A++	A+
Note	Extra white satin glass. Frosted glass recessed 30 mm into the ceiling.	Extra white satin glass. Frosted glass recessed 30 mm into the ceiling.	Extra white satin glass. Frosted glass recessed 30 mm into the ceiling. Standard: dimmable switch dim. / push (on request: dimmable 1-10V or DALI).	Extra white satin glass. Frosted glass recessed 30 mm into the ceiling.	Extra white satin glass. Frosted glass recessed 30 mm into the ceiling. Trailing-edge and leading-edge dimming (20 - 100%).

* The absorption capacity per m² calculated by the American organization TCNA (Tile Council of North America) is measured for an average room of 2,7 m in height and therefore expressed in m²