

# Binario N 10



Buzzi & Buzzi

Via Milano, 17

20060 Pozzo D'Adda (Milano)

Tel. +39 02 9094942 / 4 - Fax. +39 02 9094006

E-mail: [buzzi@buzzi-buzzi.it](mailto:buzzi@buzzi-buzzi.it) Web site: [www.buzzi-buzzi.it](http://www.buzzi-buzzi.it)

[buzzi-buzzi.it](http://www.buzzi-buzzi.it)

## AVVERTENZA:

L'apparecchio non deve essere usato senza lo schermo di protezione. In caso di danneggiamento sostituirlo prima di riutilizzare l'apparecchio. Utilizzare esclusivamente lampadine conformi alle norme C.E.I.

## AVERTISSEMENT:

L'appareil ne doit pas être utilisé sans écran de protection. Remplacer l'écran en cas d'endommagement avant de réutiliser l'appareil. N'installer que des ampoules conformes aux normes C.E.I.

## ADVERTENCIA:

El aparato no debe ser usado sin la pantalla de protección. En caso de avería de la misma, sustituirla antes de volver a utilizar el aparato. Utilizar exclusivamente bombillas conformes a las normas C.E.I.

## ACHTUNG:

Das Gerät darf nicht ohne Schutzschirm benutzt werden. Bei Beschädigung diesen auswechseln bevor das Gerät wieder benutzt wird. Es dürfen ausschliesslich Birnen verwendet werden, die den C.E.I. - Normen entsprechen.

## ATTENTION:

Do not use the unit without the safety screen. If damaged, replace it before using the unit. Use bulbs in compliance with C.E.I. Standards.

## ATTENZIONE:

Tutte le operazioni di montaggio, manutenzione e sostituzione lampadine, vanno eseguite assicurandosi che la rete di alimentazione sia disinserita.

## ATTENTION:

Toutes les opérations de montage, entretien et remplacement des ampoules ne doivent être effectuées qu'après avoir coupé le courant.

## CUIDADO:

Todas las operaciones de montaje, manutención y substitución de lámparas tienen que realizarse después de comprobar que la red de suministro está desconectada.

## ACHTUNG:

Montage, Wartung und Lampenwechsel dürfen nur nach Unterbrechung des Netzanschlusses durchgeführt werden.

## WARNING:

when carrying out all assembly, maintenance and bulbs replacement operations, make sure that the supply is OFF.

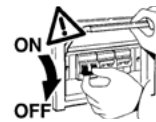

## N10 BINARIO/ NANO TRACK 48V MONTAGGIO A SOSPENSIONE O SUPERFICIE (soffitto-parete)

Low voltage track 48VDC

Circuits:

2 circuiti: 2x +/- 10A 48VDC

1 circuito : 1x +/- 10A 48 VDC+D+/D

Remote power supply

**T048 T 04 B1 1 \_ 1**

length

<b>01</b>	1000 mm
<b>02</b>	2000 mm
<b>03</b>	3000 mm

## ATTENZIONE:

La sicurezza dell'apparecchio è garantita con l'uso appropriato delle istruzioni. Pertanto è necessario conservarle.

## ATTENTION:

La sûreté de l'appareil est garantie avec l'utilisation appropriée des instructions. Il est donc nécessaire de les garder.

## CUIDADO:

La seguridad del aparato está garantizada se si hace el uso apropiado de las siguientes instrucciones. Por lo tanto es necesario conservarlas.

## ACHTUNG:

Die Sicherheit des Gerätes ist nur garantiert, wenn die folgenden Vorschriften eingehalten werden. Es ist daher notwendig diese aufzubewahren.

## WARNING:

The safety of the fitting is guaranteed by the correct use of the instructions. It is therefore necessary to keep them.

Per difetti riscontrati indicare il numero di controllo.

En cas de défauts mentionner le numéro de contrôle.

En caso de defectos hacer mención del número de control.

Für eventuell festgestellte Mängel bitte die Kontrollnummer angeben.

For any manufacturing defect refer to the check number.

Controllo  
Contrôle  
Control  
Kontrolle  
Control

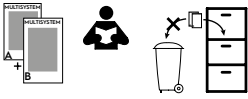

IT - Tutte le operazioni descritte in questo foglio di istruzioni devono essere eseguite da personale specializzato, escludendo tensione dall'impianto e rispettando le norme nazionali di installazione.

- L'azienda permette solo l'utilizzo dei componenti NANO all'interno delle applicazioni che utilizzano il sistema NANO. Questi componenti devono essere installati secondo le istruzioni di montaggio fornite dall'azienda.  
- L'azienda, come produttrice, non è responsabile della sicurezza e del funzionamento del sistema NANO in caso si utilizzino componenti non appartenenti ad esso o se le istruzioni di montaggio non venissero rispettate. È inoltre responsabilità del produttore di terze parti utilizzate e/o sviluppate per il sistema NANO (es. driver/apparecchi di illuminazione) garantirne il corretto funzionamento e la compatibilità elettrica, elettromagnetica, elettronica, meccanica con il sistema stesso.

- Il binario ed i suoi componenti, compresi gli adattatori, non sono intercambiabili con accessori che non riportino il Marchio di Qualità.

- Durante il montaggio dei binari rispettare le distanze di ancoraggio e non superare i carichi indicati nella relativa sezione.

- Il sistema NANO è un sistema a binario in Class III, non è compatibile con sistemi a binario in Class I o in Class III di altri costruttori. Inserire sul circuito di alimentazione le opportune protezioni affinché siano prevenuti eventuali sovraccarichi o cortocircuiti.

- È vietato utilizzare alimentatori, driver, sistemi Bus Dati e componenti non omologati SELV e/o che abbiano una U-OUT maggiore di 60 V dc.

- In caso fosse necessario all'interno della stessa installazione (edificio, negozio etc) creare un unico BUS DATI unendo elettricamente il BUS DATI del binario a bassa tensione con quello di altri apparecchi di illuminazione è necessario che tutti i componenti utilizzati siano classificati SELV. BUZZI&BUZZI raccomanda l'utilizzo di un ripetitore optoisolato (es. T048 A 00078 00).

- È severamente vietato utilizzare qualsiasi tipo di solvente, colla, olio, sgrassatore o detergente a contatto con tutti i componenti del sistema NANO. L'azienda non è responsabile di eventuali danni causati dall'utilizzo di suddetti materiali.

- Il distributore ha l'obbligo di informare l'utente sulle modalità di utilizzo di tutti i componenti forniti.

- Materiali, disegni, programma di fabbricazione e confezioni possono subire modifiche o variazioni senza obbligo di preavviso.

- Si declina ogni responsabilità per eventuali errori di stampa.

#### IT - INFORMAZIONI TECNICHE

- Tensione (in entrata): 0 – 60 V dc

- Corrente: max. 10A - 1A bus dati

- T massima di funzionamento: 70°C (Ta 25°C)

- Classe III (SELV)

- Cavi per cablaggio testata: 2xAWG16 + 2xAWG22

- Certificazione UL 48V-2A Class 2-1A bus dati.

- Peso massimo dell'apparecchio di illuminazione: 5N con adattatore.

- Binari per utilizzo in versione NON polarizzata.

- Componenti plastici disponibili solo nella versione NON polarizzata.

- Usare solo elettroniche NON polarizzate

- Non inserire l'adattatore nelle parti di binario curve

- ATTENZIONE: per limitare il rischio di surriscaldamento e di incendio non

cortocircuitare i conduttori

- La sostituzione del cavo della testata può essere effettuata solo dal costruttore o dal suo servizio di assistenza.

EN - All the described operations of this instructions page must be done by specialized personnel only, shutting of the electrical power and respecting all national installation regulations and guidelines.

- The company allows the use of only NANO parts in applications where the NANO system is installed. These parts must be installed according to the installation instructions supplied by the company itself.

- The company as a manufacturer is not responsible for the safety and functioning of the NANO system if components not belonging to it are used or if there are any deviations from the installation instructions. It is then the third-party manufacturer's responsibility to ensure the correct functionality and the electrical, electromagnetic, electronic, mechanical compatibility between the NANO system and any other third-party products that are used or even developed for the system itself (e.g. drivers/light fixtures).

- The track, its components and also the adapters can't be used with accessories

without the Quality/Approval Mark of the region.

- Do not exceed listed loading indicated in the relevant section and respect fixing distances during the track mounting.

- This track system is Class III and is not compatible with Class I track systems or Class III track systems from other manufacturers. Insert the appropriate power circuit protections in order to prevent short circuits or overloads.

- It is forbidden to use control gear, drivers, DATA BUS systems and components that are not SELV-approved and/or with U-OUT greater than 60 VDC.

- If in an installation (building, shop, etc.) the track system is being integrated with a larger lighting control system electrically merging the DATA BUS of the low-voltage track with that of other light fittings, all components used must be SELV-approved. BUZZI&BUZZI recommends to use an opto-insulator repeater (es. T048 T 04 B1 1 01 1).

- It is strictly forbidden to use any kind of solvent, glue, oil, grease or cleaner in contact with NANO system components. The company is not responsible of any damage caused by the use of the materials mentioned above.

- The distributor is obliged to provide its customers with guidance on the correct use of all components supplied.

- Materials, design, our development program and packages may be subject to changes without notice.

- We decline responsibility for any misprint.

#### EN - TECHNICAL INFO

- Supply Voltage (input): 0 – 60 V dc "The supply voltage must be between 0 and 60 VDC"

- Supply Current: max. 10A - 1A data bus "supply current must not exceed 10 A - 1A data bus"

- Max operating temperature: 70°C The operating temperature must not exceed 70°C (Ta 25°C)

- Class III (SELV) "The MULTISYSTEM track is a Class III - SELV product"

- End Feed wiring cables: 2xAWG16 + 2xAWG22 cables to wire the end power feed."

- UL certification 48V-2A Class 2.

- Maximum weight of the lighting fixture: 5N with adapter

- Tracks to be used in NON polarised version.

- The plastic components are supplied only in NON-polarised version.

- Use only NON polarized electronics

- Do not insert the adapter in the curved track parts.

- ATTENTION: to reduce the risk of overheating and fire do not bridge conductors

- The replacement of the NANO end-feed cable can only be carried out by the manufacturer or its customer service

#### TECHNICAL INFO FOR USE AS PER

##### c UL US APPROVAL

When installing or using this track system, basic safety precautions should

always be followed, including the following:

1. Read all instructions.

2. Do not install this track in damp or wet locations.

3. (Unless provision for field cutting) Do not cut any track section.

4. Do not install any part of a track system less than 5 ft above the floor.

5. Do not install any fixture assembly closer than 6 in from any curtain or similar combustible material.

6. Disconnect electrical power before adding to or changing the configuration

of the track.

7. Do not attempt to energize anything other than lighting track fixtures on

the track. To reduce the risk of fire and electrical shock, do not attempt to

connect powertools, extension cords, appliances, and the like to the track.

8. (For track lighting systems other than 120 V, two-wire) Do Not connect

the track to more than one branch circuit unless the track is constructed so

that it can be used with more than one branch circuit. Check with a qualified

electrician. Although the track lighting system may seem to operate acceptably,

a dangerous overload of the neutral may occur and result in a risk of fire.

9. The track system is not intended for use with a power supply cord or

convenience receptacle adapter.

10. For recessed version please use drywall

thickness: 1/4"; 5/16"; 3/8"; 1/2"; 5/8".

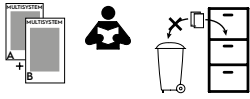

# Binario N-10

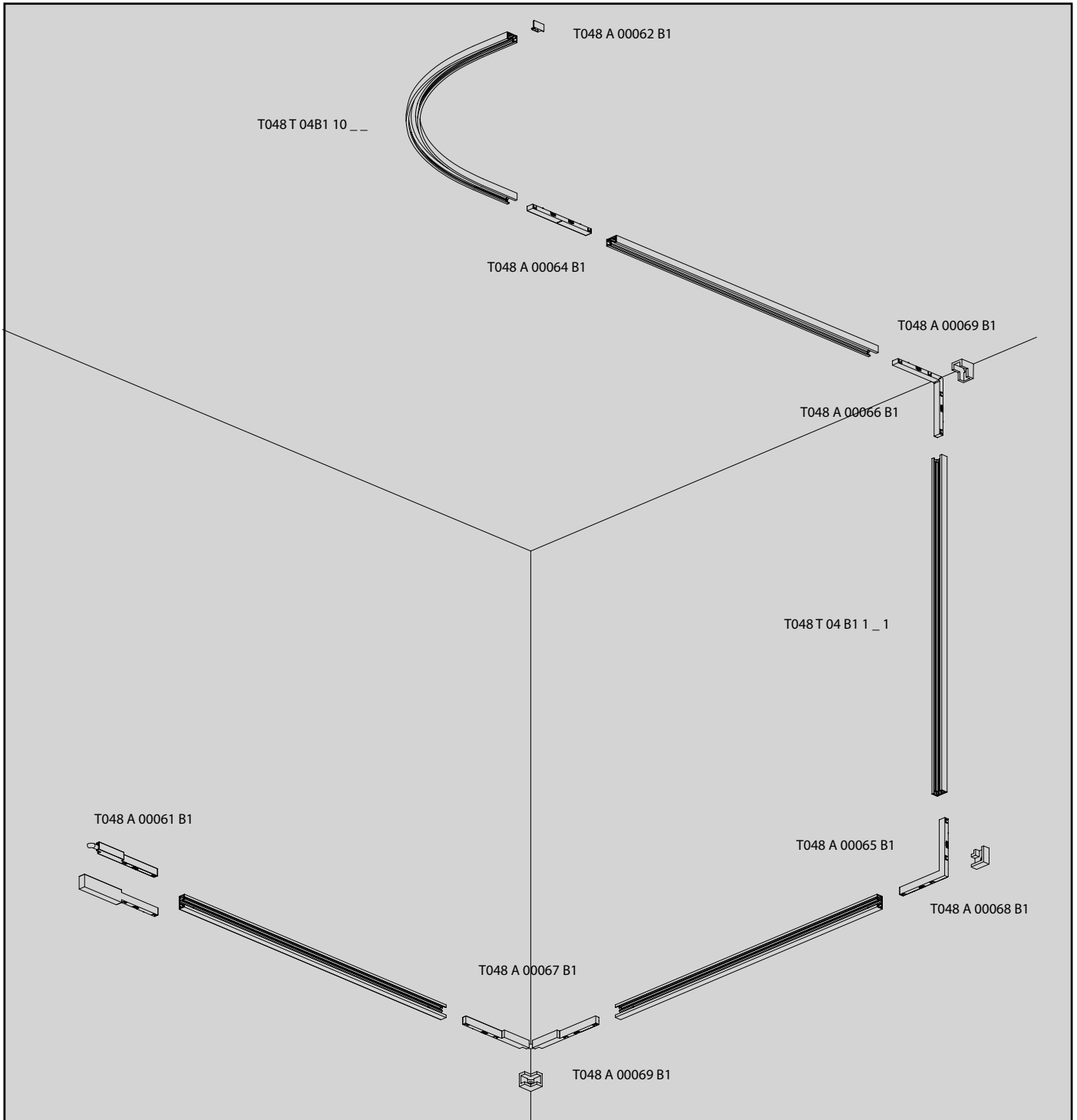

**T048 T 04 B1 1 \_ 1**

**T048 T 04B1 1051**

**T048 T 04B1 1041**

CODE	L mm [ft]
T048 T 04 B1 1 01 1	1000 [3.28']
T048 T 04 B1 1 02 1	2000 [6.56']
T048 T 04 B1 1 03 1	3000 [9.84']

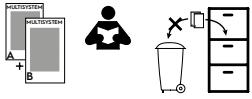

# Binario N-10



## 1- USE

Ceiling - Wall



## 3 - CEILING FIXING

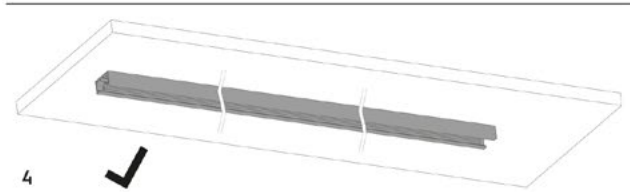
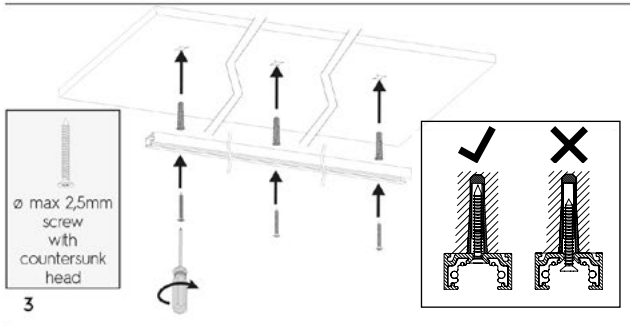
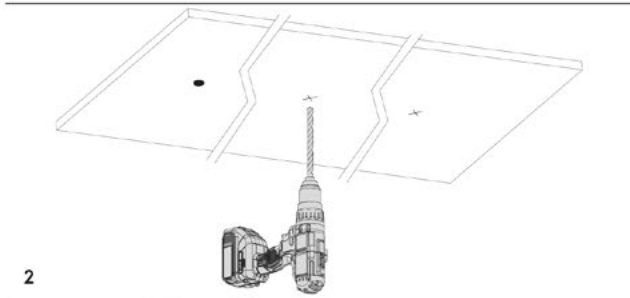
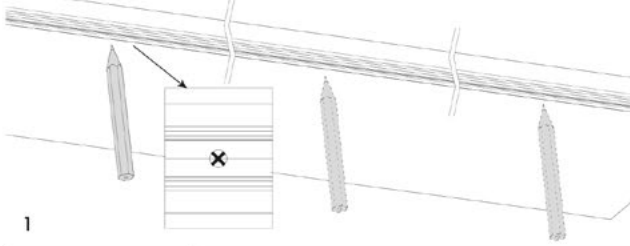

## T048 A 00061 B1

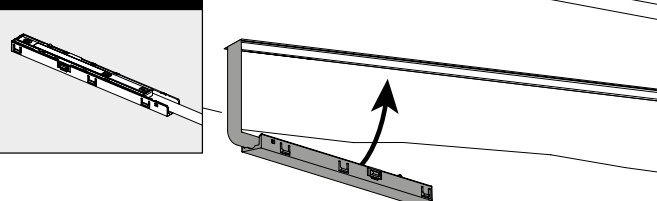

## T048 A 00064 B1

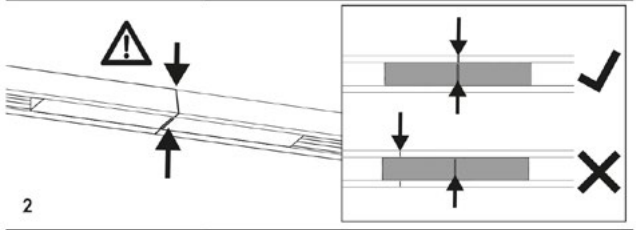
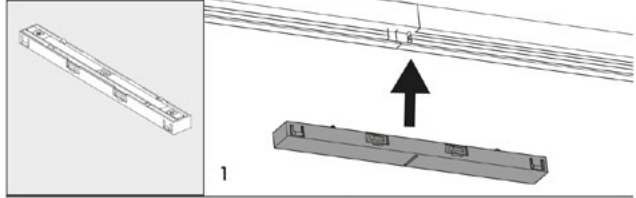

## T048 A 00068 B1

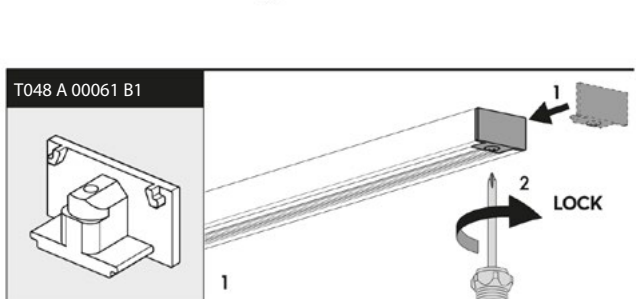
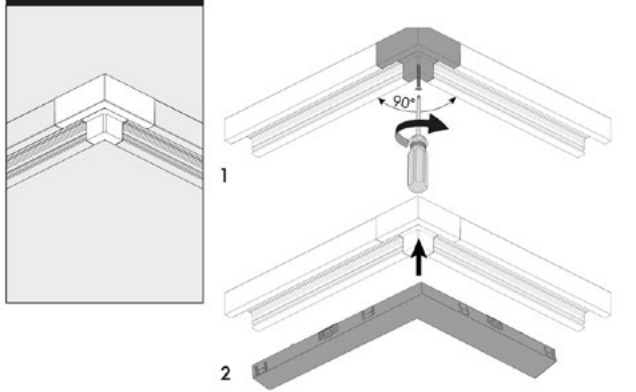

## T048 A 00061 B1

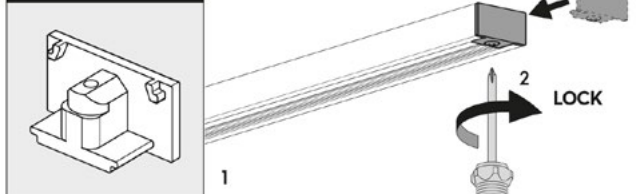

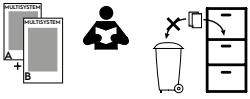

# Binario N-10



T048 A 00069 B1

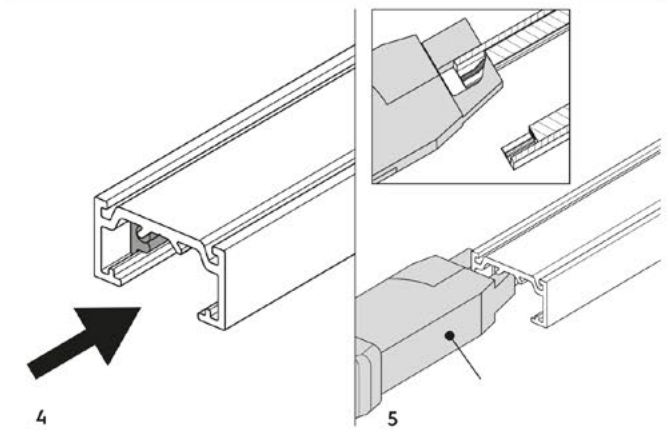
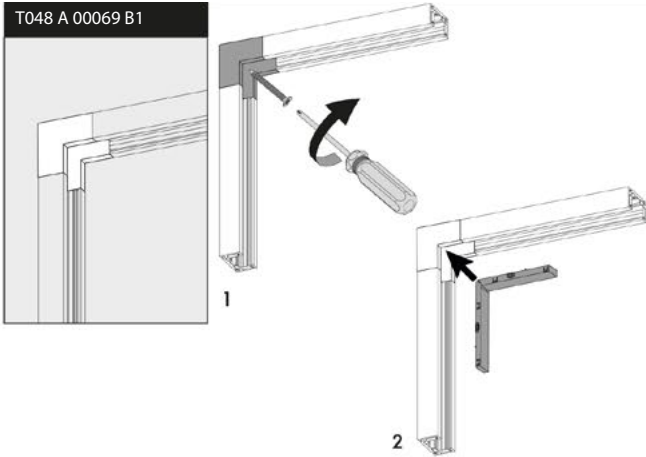

## 4 - WARNING

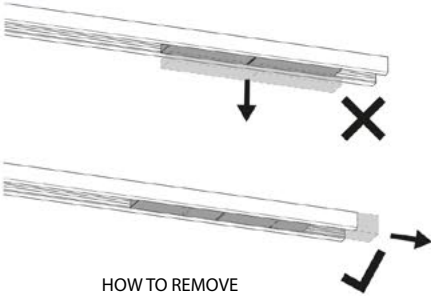

HOW TO REMOVE

**FOR ALL CONNECTIONS AND END-FEEDS**



**VALID FOR ALL NANO TRACK SERIES**

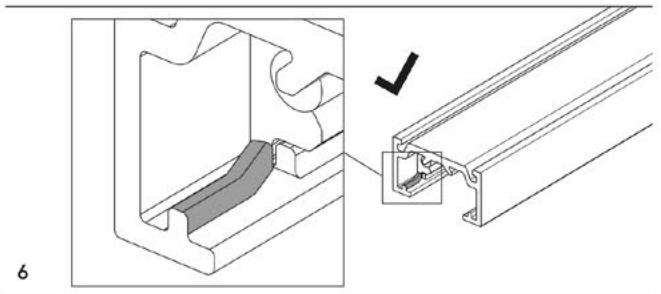

## 5 - CUTTING

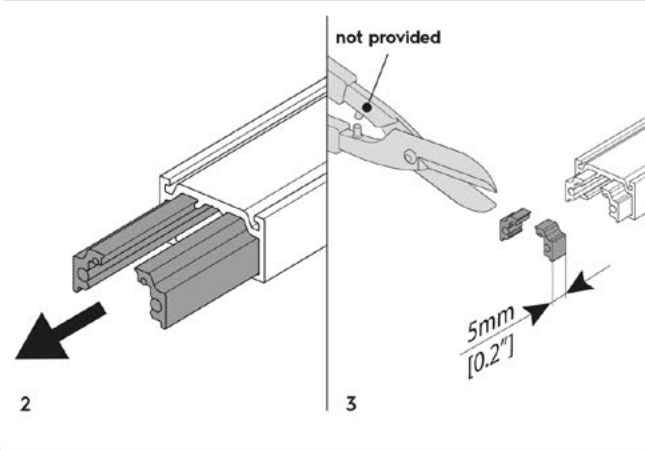
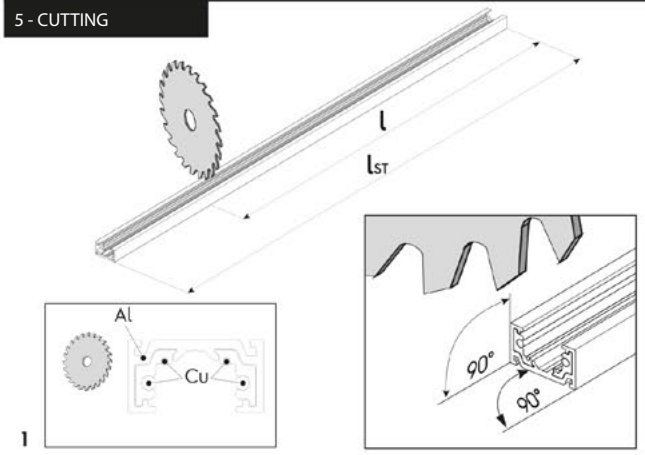

PLEASE ENSURE THAT THE DATA BUS WIRING DOES NOT CREATE A RING STRUCTURE. A FAILURE-FREE DATA BUS CANNOT BE ENSURED IF ONE IS PRESENT.

IF THE TRACK INSTALLATION REQUIRES THE USE OF "L", "T" OR "X"-SHAPED JOINT, IT IS POSSIBLE TO DISCONNECT THE DATA BUS IN THESE JOINTS TO AVOID CREATING A RING STRUCTURES.

--- Bus Data